

LED SMD HIGH BAY

Code:
ASTREK15050

5 YEARS
GUARANTEE



Application

- Suitable for industrial lighting application and sports facilities

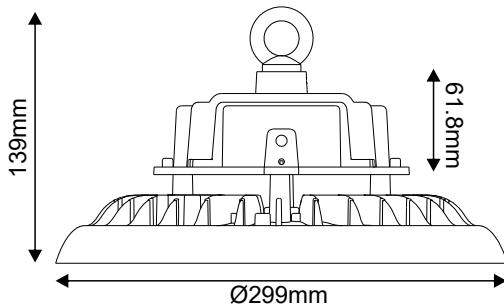

Technical Data

Housing Material	Die-casting Aluminum
Optic Material	Polycarbonate
Color	Black
Input Voltage	230V AC
Input Frequency	50~60Hz
Total Wattage	150W
LED Type	SMD (LM80)
Lifespan	50.000 hours
Protection Class	CLASS I
Ingress Protection	IP65
Mechanical Impact Degree	IK08
Surge Protection	4kV
Total Harmonic Distortion (THD)	<10%
Power Factor	≥0.95
Operation Temperature	-40°~+50°C
LED Driver	SOSEN (Built-in)
Dimming	1-10V (10-100%)
Replaceable LED / Driver	Yes / Yes
Power Supply Cable	3*1.00mm ² (1000mm)

Photometrical Data

Color Temperature	5000K
Lumen	19500Lm
Light Beam Spread	90° Symmetrical
Color Rendering Index (Ra)	≥80

Energy Data

Energy Efficiency Label	E
Energy Consumption	150.0 kWh/1000h

The technical data of the product may differ from the listed +/- 10%



APOSTOLIDIS TRADING
Industrial area of Serres | 62100 Serres, Greece
T. +30 23210 77020-21 | F. +30 23210 77022
info@acalight.gr | www.acalight.gr

