

LED SMD PARK & STREET LUMINAIRE

Code:
DIVEA6040L

5 YEARS
GUARANTEE



Application

- Suitable for park & street lighting

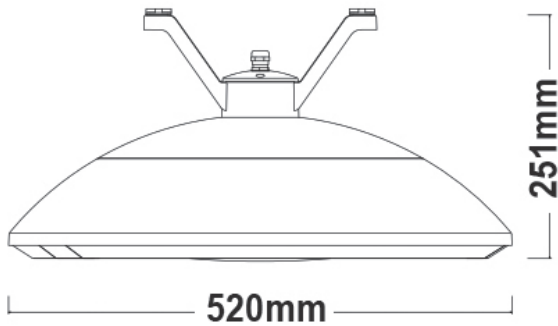

Technical Data

Housing Material	Die-casting Aluminum
Optic Material	Polycarbonate + Glass
Color	Grey (RAL9023)
Input Voltage	230V AC
Input Frequency	50~60Hz
Total Wattage	60W
LED Type	SMD (LM80)
Lifespan	72.000 hours
Protection Class	CLASS I
Ingress Protection	IP66
Mechanical Impact Degree	IK10
Surge Protection	10kV
Function Temperature	-30°~+45°C
LED Driver	Yes (Built-in)
Replaceable LED / Driver	Yes / Yes

Photometrical Data

Color Temperature	4000K
Lumen	7500Lm
Light Beam Spread	80°x150°
Color Rendering Index (Ra)	≥70

Energy Data

Energy Efficiency Label	D
Energy Consumption	60.0 kWh/1000h

The technical data of the product may differ from the listed +/- 10%



APOSTOLIDIS TRADING
Industrial area of Serres | 62100 Serres, Greece
T. +30 23210 77020-21 | F. +30 23210 77022
info@acalight.gr | www.acalight.gr

