

LED SMD LUMINAIRE

5 YEARS
GUARANTEE



Application

- This luminaire is suitable for outdoor installation
- Suggested for general lighting

Technical Data

Housing Material	Aluminum
Optic Material	Glass
Color	Grey (RAL 7016)
Input Voltage	230V AC
Input Frequency	50~60Hz
Total Wattage	200W
LED Type	SMD (LM80)
Lifespan	50.000 hours
Protection Class	CLASS I 
Ingress Protection	IP66
Mechanical Impact Degree	IK08
Ambient Temperature Range	-30° ~ +50°
Surge Protection	6kV
LED Driver	Yes (Built-in)
Dimming	No
Replaceable LED / Driver	Yes / Yes

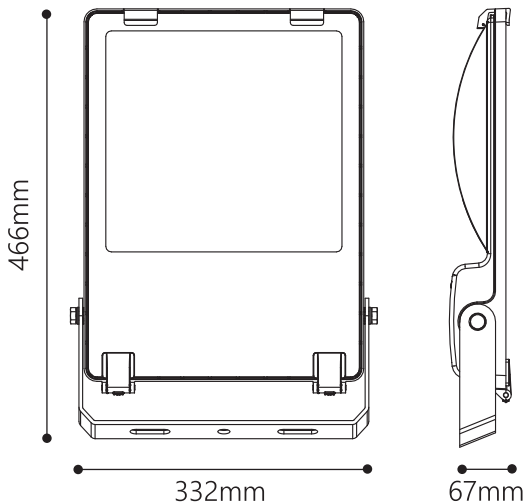

Photometrical Data

Color Temperature	4000K
Lumen	31000Lm
Light Beam Spread	110°
Color Rendering Index (Ra)	≥70

Energy Data

Energy Efficiency Label	C
Energy Consumption	200.0 kWh/1000h

The technical data of the product may differ from the listed +/- 10%

